

**Unicont SPb Ltd**

# **Connection box SCB-133**

Technical Documentation

(133-1-19042013)

**St. Petersburg**  
2013

v.1.1

---

## Table of Contents

1. GENERAL.....	4
2. DELIVERY SET .....	4
3. GENERAL ARRANGEMENT .....	4
4. INSTALLATION AND CONNECTION.....	5
5. TRANSPORTATION AND STORAGE.....	11
6. RECYCLING .....	12
7. WARRANTY .....	13
8. DATE OF PACKING .....	14
9. ACCEPTANCE DETAILS .....	14
10. DATE OF COMMISSIONING .....	14

This Operating Manual applies to the SCB-133 Connection box.

This Manual is intended to assist in the familiarization with the design, operating principles and procedures established for the convection heater during its intended use or maintenance. This Manual can also be used as a source of information about сведений об устройстве to draw up corresponding sections in the operational documentation for the equipment, в которой this product may be used as its component part.

All information contained in this Manual is distributed by the company for information purposes only. The information is subject to changes without notification to consumers; the information may contain errors or discrepancies. The information provided may not contain obligations on the part of Unicont SPb Ltd

## 1. General

The SCB-133 connection box is an equivalent for the TT-3616D (SAILOR) connection box. This connection box is used with the Inmarsat mini-C SAILOR ship earth stations (SES), type TT-3026xx (TT-3026M, TT-3026S, TT-3026D, TT-3026L, TT-3000SSA, etc.).

## 2. Delivery set

1. SCB-133 connection box	1
2. Earthing cable	1
3. Set of cable fasteners	1
4. Operating manual	1

## 3. General arrangement

The SCB-133 considerably simplifies the mounting process of the SES components (transceiver, antenna cable and alert buttons) and additional devices (power supply unit, shipboard computer, etc.).

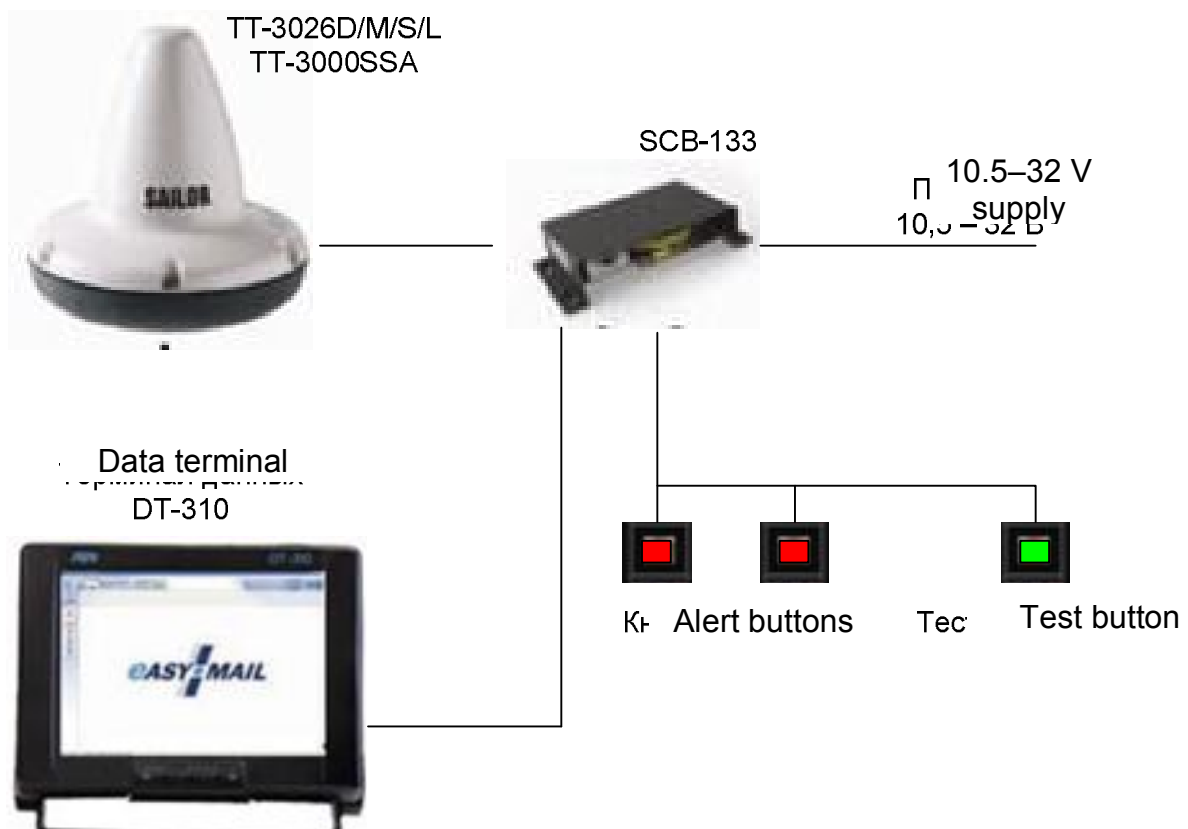

Fig. 1. Connection of the SES using the SCB-133

## 4. Installation and connection

### 4.1 Installation

The connection box is installed on a vertical bulkhead or mounting panel. The SCB-133 should be installed at a maximum distance of 50 meters from the transceiver. Recommended installation clearances are shown on the figure below (Fig. 2).

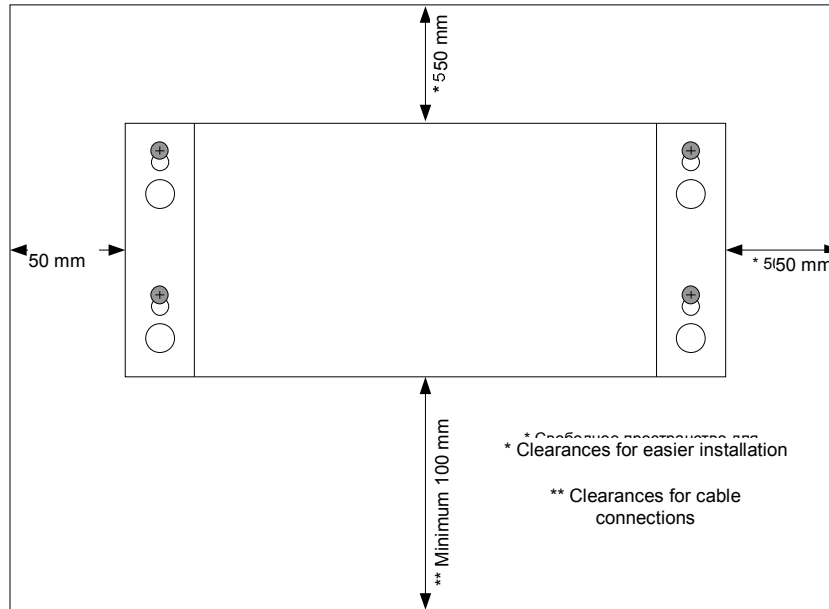

Fig. 2. Recommended installation clearances for the SCB-133

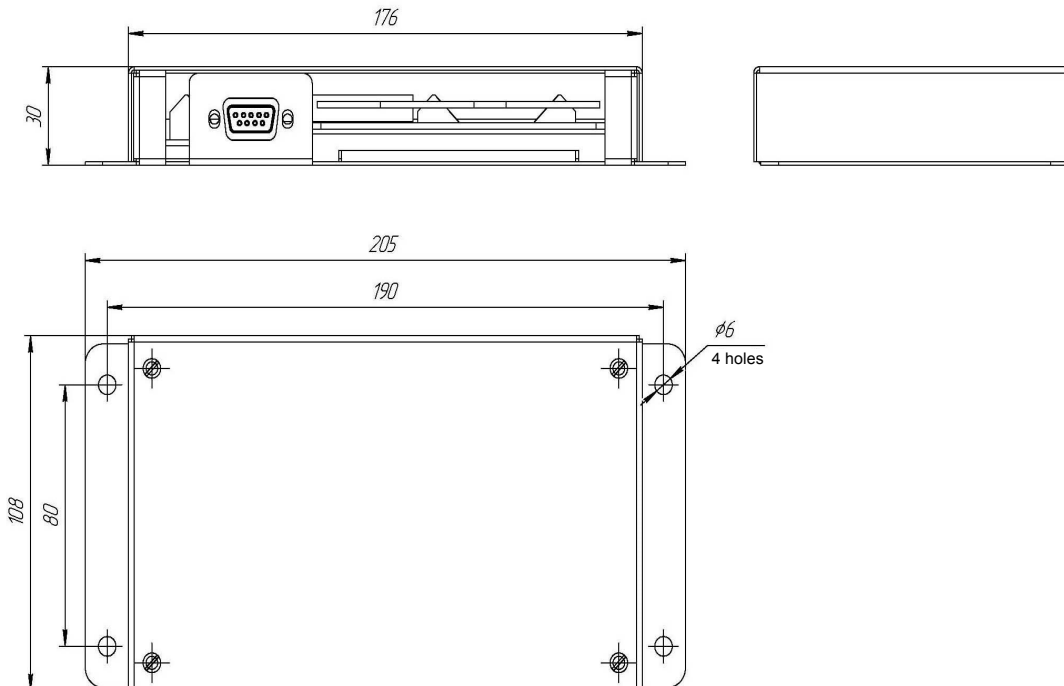

Fig. 3. SCB-133 connection box. Dimensional drawing

## 4.2 Connections

Using a special tool supplied with the set of fasteners will make the connection of leads much easier.



### Caution!

**Do not apply excessive pressure on the tool to prevent damages of the connection box.**

Fig. 4. Tool

The connection box includes a PCB with the following components:

- clamp-type terminals to connect leads of (up to 2.5 mm in diameter) of the power supply unit, buttons and transceiver;
- DB-9F connector to connect the onboard computer (e.g., the DT-310 data terminal).

### Connecting the earthing lead

The connection box includes the earthing lead, 1 m long. One end of the lead is fixed to the metal base of the connection box (see Fig. 5), and the other end is connected to the ship's metal structure. Do not use larger lengths of the earthing lead since it will result in degradation of the magnetic field protection.



Fig. 5. Connecting the earthing lead to the SCB-133

### Power supply connection

To connect the power supply cable, fix its shield to the connection box using a metal plank. The positive lead is attached to the DC+ terminal; the negative lead is connected to the DC- terminal (see Fig. 6). When the connections are made correctly, the red LED in the top part of the PCB to the right of the J1 terminal will light up after the voltage is supplied to the unit.



Fig. 6. Connecting the power lead

### Connecting the TT-3026xx to the SCB-133

To connect the transceiver to the connection box, follow the below procedures:

1. Strip the cable insulation at a distance of 200 mm (see Fig. 7).
2. Wrap the cable shield around the cable insulation as shown on the below figure (Fig. 8).
3. Fix the cable using a metal plank of the connection box (see Fig. 9).
4. Connect the transceiver cable following the color markings on the PCB (see Fig. 10).



Fig. 7. Preparing the transceiver cable

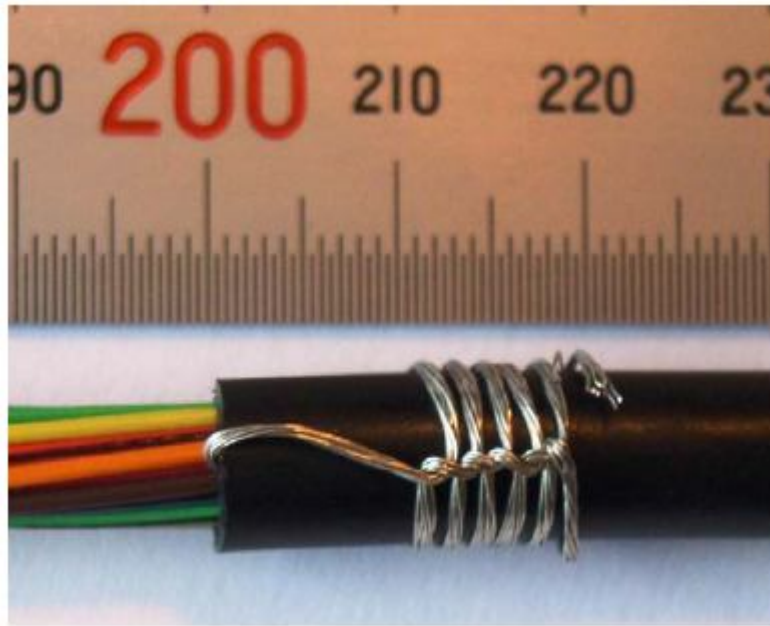

Fig. 8. Preparing the transceiver cable shield



Fig. 9. Fixing the transceiver cable

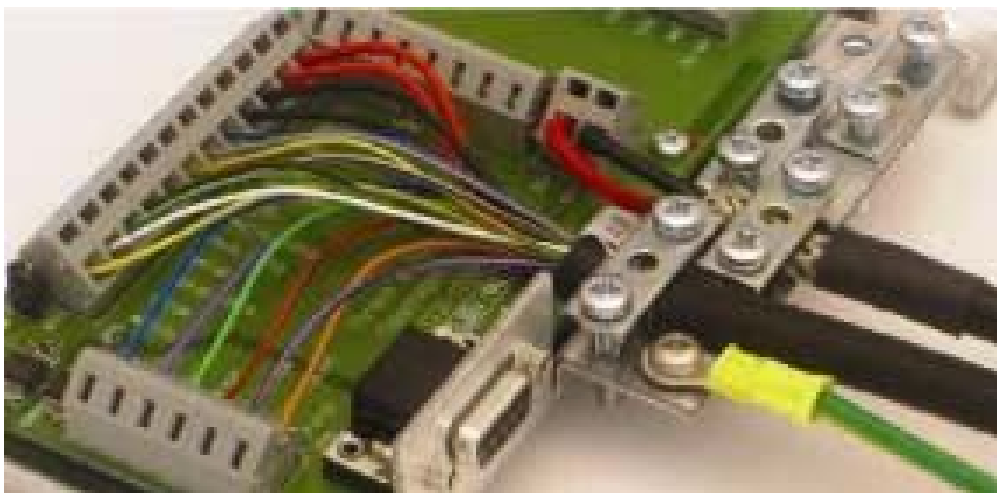

Fig. 10. Example of the transceiver cable connection



### Connecting the buttons

The red alert button (3-lead) is included in the delivery set of the station. When 2 or more alert buttons are required, additional buttons (4-lead) can be installed.

To make the installation process of the alert buttons easier, you can use color code templates to connect 2, 3 or 4 buttons. An example of these templates is shown on the figure below (Fig. 11); the template originals in full scale of the terminal contacts are given in the documentation supplied with the station. Copy the required template on a sheet of paper; cut and put it on the installation place as shown on the figure (Fig. 12).

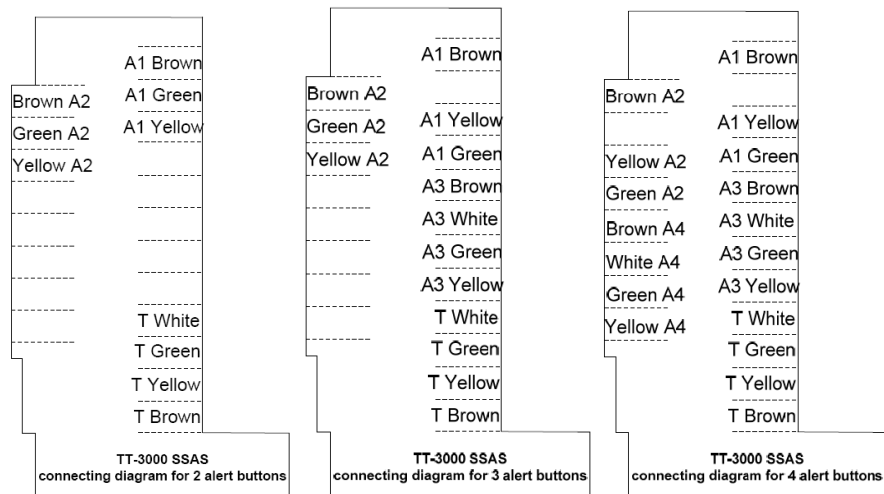

Fig. 11. Color code templates

These templates are given in the original documents provided by the station manufacturer, i.e. Thrane & Thrane (doc No. 98-120343 ver.G, release date 13.05.2009). To prevent incorrect connection of the equipment, please read carefully the documentation for your station and make sure that no changes have been made.

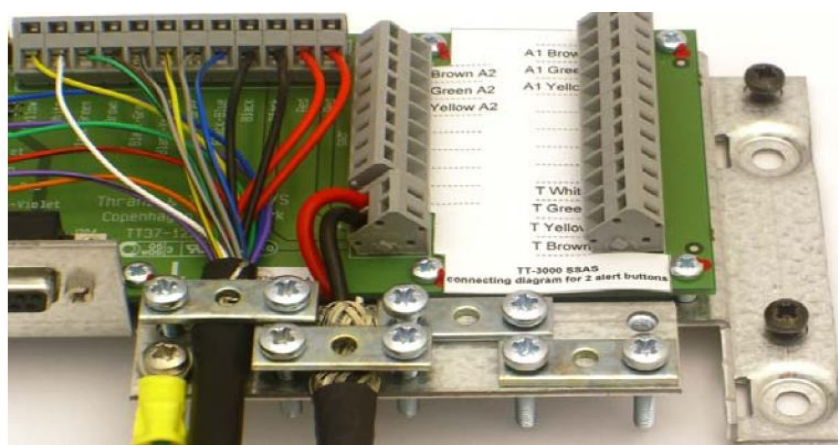

Fig. 12. Using a template for 2 alert buttons

An example of connecting the connection box with cables is shown on the figure below (Fig. 13). To make sure that the cables and buttons are connected correctly, check the performance of the entire system (refer to the description of the connected station).



Fig. 13. Connecting the cables of the connection box with 2 alert buttons

## 5. Transportation and Storage

The device shall be stored in heated space at air temperature of +5 °C to +35 °C (maximum values of -55 °C to +70 °C), at relative humidity of air not exceeding 95 % at temperature of +25 °C and content of dust, oil, moisture and aggressive admixtures in the air not exceeding the norms envisaged by GOST 12.1.005-88 for the working zone of production areas.

The device shall be transported in transport container of the manufacturer in closed transport.

Means of transport:

- automobile and railway closed transport (covered wagons, universal containers)
- by air (in pressurized and heated bays of airplane)
- by sea (in dry service spaces).

The device shall be transported in accordance with the transport regulations in force for the particular transport.

During handling operations and transportations strictly observe the requirements of handling marks on boxes and do not allow bumps and impacts which can affect preservation and serviceability of the device.

Packed devices shall be reliably secured in vehicles.

After storage in stores or transportation at temperature below +10 °C the devices shall be unpacked only in heated spaces after keeping them unpacked in under normal climatic conditions for 12 hours.

## 6. Recycling

Do not recycle the packing of a new product, its parts with defects identified during its operation as well as the overage product as common household waste since they contain materials and raw materials suitable for their recovery.

Decommissioned and unused components should be delivered to a specialized waste collection center licensed by local authorities. You can also send the overage equipment to the manufacturer for its further recycling.

Proper recycling of the product components will prevent potential negative consequences for human health and the environment, as well as provide recovery of the product component materials while substantially saving on energy and resources.

**The product does not endanger human life and health or the environment during and after its service life.**

**This product should be recycled following the requirements applicable to electronic equipment.**



**Products marked with a crossed-out recycle bin should be recycled apart from common household waste.**

## 7. Warranty

The manufacturer guarantees the unit SCB-133 complies with this manual provided that the operation, transportation and storage conditions are adhered to during the warranty period.

The unit's warranty period expires 24 months from the date of its shipping from the manufacturer's storehouse.

Within the warranty period, the owner is entitled for a free repair, or a replacement of a separate part, provided that the malfunction occurred through the manufacturer's fault.

Warranty repair is provided if the unit is submitted with the manufacturer's label and a legible serial number available on it, as well as this operating manual.

The manufacturer is not responsible and cannot guarantee the unit's operation:

1. After the warranty period is over;
2. In case of the failure to observe the unit's operation, transportation, storage and installation rules and conditions;
3. If the unit is in an unmarketable condition, or has a damaged body, and other causes beyond the manufacturer's control;
4. If self-made electrical devices were used.
5. If there was an attempt to repair the unit by a person who is not an authorized representative of the manufacturer.

If the owner loses this operating manual or the manufacturer's label with a serial number, the manufacturer shall not provide their copies, and the owner shall be divested of the right for a free repair during the warranty period.

Upon the warranty expiry, the manufacturer shall facilitate the repair of the unit at the owner's expense.

Note: in case of warranty repair, the unit's disassembling from the installation site and its delivery to the manufacturer's service center are done at the owner's expense.

Visit the manufacturer's website [www.unicont.spb.ru](http://www.unicont.spb.ru) (section "support/warranty") to find:

- forms to fill in claims,
- full warranty description;
- full description of the warranty service rendering procedure.

**The manufacturer service center's address and contact details:**

**Unicont SPb, Ltd.**

**Bld. 26E Kibalchich Str., Saint Petersburg, 192174, Russia**

**tel.: + 7 (812) 622 23 10, +7 (812) 622 23 11**

**fax: +7 (812) 362 76 36**

**e-mail: [service@unicont.spb.ru](mailto:service@unicont.spb.ru)**

## 8. DATE OF PACKING

Connection box	SCB-133	№
name of article	designation	serial number

Packed Unicont SPb Ltd., Russia.  
Manufacturer

according to the requirements of the current technical documentation.

post	signature	clarification of signature
------	-----------	----------------------------

year, month, day

## 9. ACCEPTANCE DETAILS

Connection box	SCB-133	№
name of article	designation	serial number

was manufactured and accepted in accordance with the regulatory requirements of the state standards and applicable technical documentation, and is suitable for operation.

Quality control representative

Stamp here	signature	clarification of signature
---------------	-----------	----------------------------

year, month, day

## 10. DATE OF COMMISSIONING

Connection box	SCB-133	№
name of article	designation	serial number

The unit has been put into operation.

Date of installation: \_\_\_\_\_

Place of installation: \_\_\_\_\_

Person in charge of installation: \_\_\_\_\_